

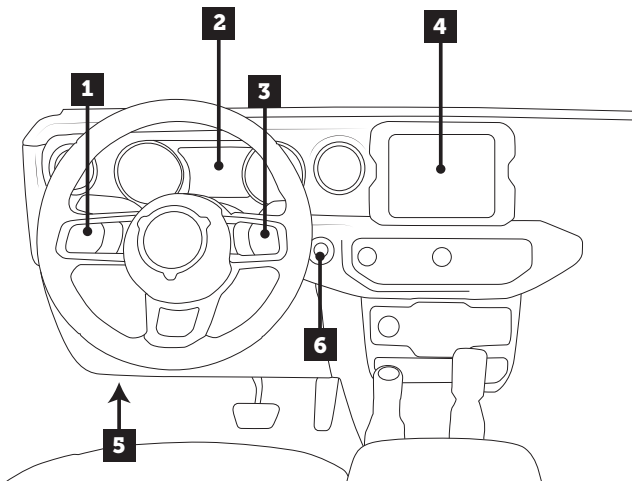

USER GUIDE | JL WRANGLER & GLADIATOR

AEV30348AB



1. INSTRUMENT CLUSTER DISPLAY CONTROL BUTTONS
2. INSTRUMENT CLUSTER DISPLAY
3. CRUISE CONTROL BUTTONS
4. STEREO DISPLAY
5. OBDII PORT
6. ENGINE START/STOP BUTTON

OVERVIEW

The AEV ProCal SNAP is a simple, easy to use electronic recalibration module for Jeep JL Wrangler and Gladiator. ProCal SNAP has the ability to recalibrate your vehicle's speedometer to compensate for non-factory tire sizes, replacement axle gear ratios and aftermarket or different transfer case gear ratios by simply plugging into the OBDII diagnostic port and inputting the numerical values using the stereo's audio equalizer.

PLEASE read these instructions completely before attempting to use this module. Follow these order of operations:

1. Install the included **AEV ProCal Harness** using instructions from aev-conversions.com.
2. Pair ProCal SNAP to the vehicle.
3. Recalibrate vehicle with ProCal SNAP

NOTE: The ProCal SNAP does not record the changes into your vehicle's history with FCA/Jeep. Any Warranty or Recall that requires a re-programming of the modules may erase the ProCal SNAP settings and require you to use the ProCal SNAP to adjust your settings again.

PAIR PROCAL SNAP TO VEHICLE

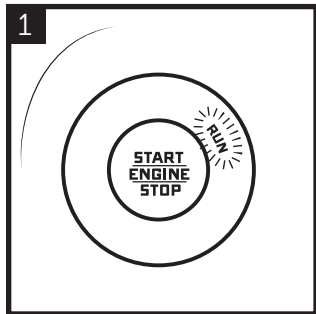

1 Press 2 times to put into the "RUN" position.

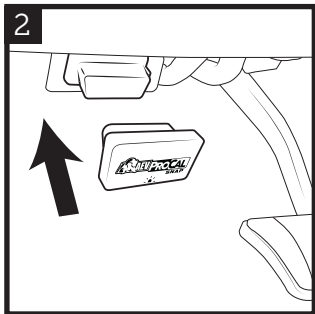

2 Insert ProCal SNAP into the OBDII port.

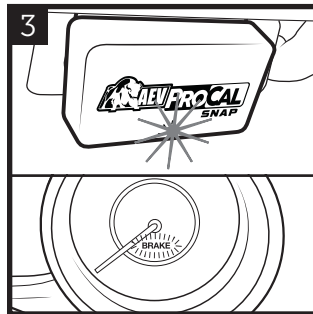

3 Wait for a blinking GREEN light on the SNAP and a blinking BRAKE light on the speedometer.

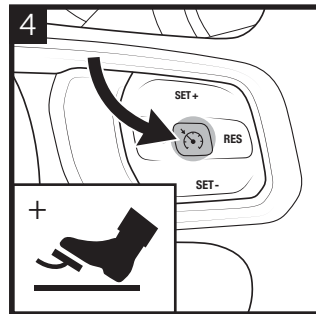

4 With your foot on the brake, PRESS and HOLD the CRUISE ON/OFF button for 3 SECONDS.

NOTE: The ProCal SNAP must be paired to a vehicle before it will recalibrate any settings. Once completed, the ProCal SNAP will be **permanently locked to this vehicle.**

5 **HONK! HONK! HONK!** When the pairing process is complete, the horn will sound quickly 3 times. Your ProCal SNAP is now paired and ready to recalibrate your vehicle.

SETTING EQUALIZER

Adjust the stereo's EQUALIZER SETTINGS to the values you wish to set (be sure the stereo source is set to AM/FM).

Always enter the values in order: Bass, Mid, Treb.

- Example: 34.2" Tires, Bass = 3, Mid = 4, Treb = 2.

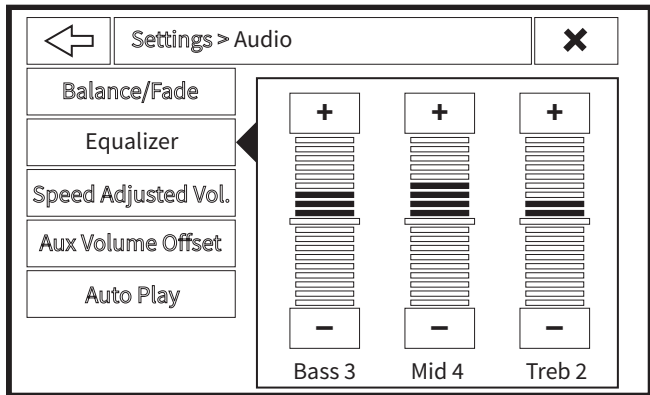

UCONNECT 4 and 4C

Note that some stereos display EQ horizontally with Bass at the bottom. **It is important to remember all settings must be entered in the correct order, Bass, Mid, Treb.**

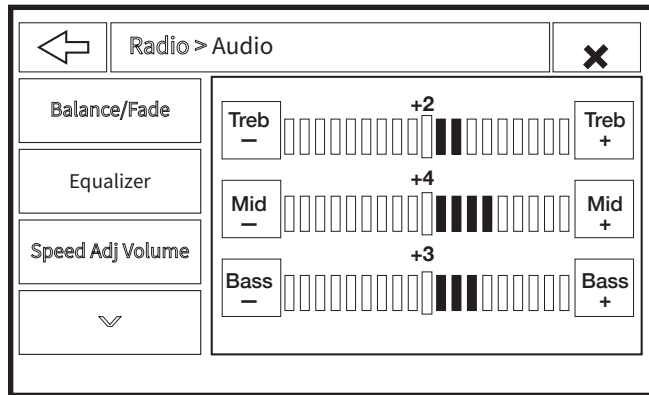

UCONNECT 3

EXAMPLE: TIRE SIZE

To recalibrate Tire Size: Begin by physically measuring your tire diameter IN INCHES from the ground to the top of front tire with the vehicle level and on the ground.

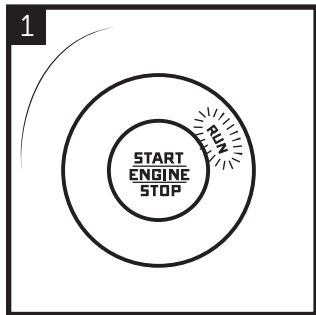
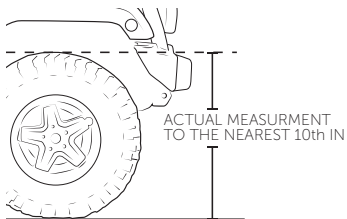

Press 2 times to put into the "RUN" position.

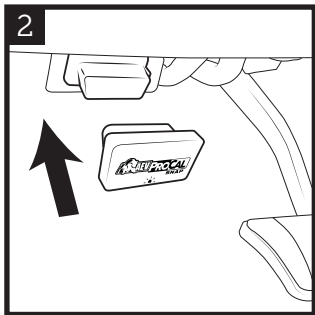

Insert ProCal SNAP into the OBDII port.

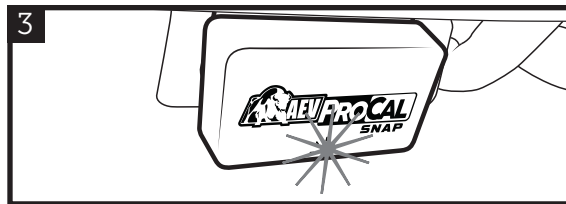

Wait for a solid GREEN light on the SNAP.

- 4 Set the EQ values for the tire size (Example: 34.2" Tires, Bass = 3, Mid = 4, Treb = 2.). Press the combination below. PRESS and HOLD for 3 SECONDS. Programming is complete when the horn sounds twice. Unplug ProCal SNAP and store in vehicle.



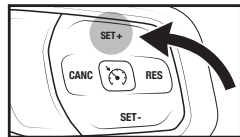

BRAKE PEDAL

+

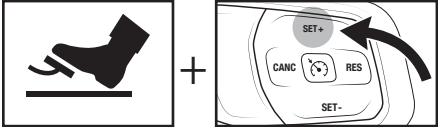

SET +

FUNCTION	DESCRIPTION
TIRE SIZE	When setting Tire Size, use the actual height measurement, not the rated size.
AXLE RATIO	The physical ratio of gears in your differential. Do not modify unless you have changed gears.
TRANSFER CASE	The physical ratio of gears in your Transfer Case. Do not modify unless you have replaced the transfer case.
TPMS	Indication light shuts off at this value, and will turn on when one tire is 75% of this value. RANGE: 30-50psi

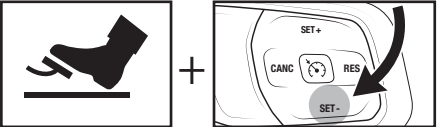
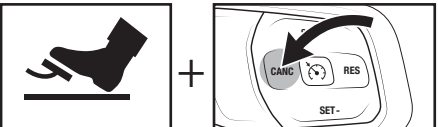
EQ EXAMPLE	COMBINATION
34.2" Tires B: 3, M: 4, T: 2	 BRAKE PEDAL + SET +
4.10 Axle B: 4, M: 1, T: 0	 BRAKE PEDAL + RES
3.80 T-Case B: 3, M: 8, T: 0	 BRAKE PEDAL + SET -
32 PSI B: 0, M: 3, T: 2	 BRAKE PEDAL + CANC

ADDITIONAL FUNCTIONS

To use ProCal SNAP to clear DTC codes or restore your vehicle's factory settings, follow programming steps 1 and 2 then PRESS/PULL and the combinations below and HOLD for 3 SECONDS.

CLEAR DTC CODES



BRAKE PEDAL

+

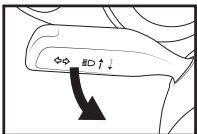

PULL HIGH BEAM

+

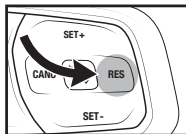

RES

RESTORE FACTORY SETTINGS



BRAKE PEDAL

+



PULL HIGH BEAM

+

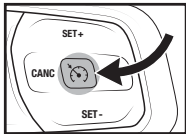







CRUISE ON/OFF

VIEW SETTINGS

If you wish to view the current settings, you can do so on the Instrument Cluster Display. Insert the ProCal SNAP into the OBDII port. Turn the radio off and use the Instrument Cluster Display Control Buttons to navigate to AUDIO. The Instrument Cluster Display will cycle through showing the current setting for **Tire Diameter**, **Axle Ratio**, and **4Low Ratio**.

DIAGNOSTIC CODES

-  **BLINKING GREEN:** ProCal SNAP ready to pair
-  **SOLID GREEN:** ProCal SNAP paired and ready
-  **SLOW PULSING ORANGE:** Waiting for vehicle ignition to be turned to RUN.
-  **SLOW PULSING BLUE:** Inserted into incorrect vehicle.
-  **FAST PULSING ORANGE:** No connection. Check that the harness is properly installed.
-  **FAST PULSING BLUE:** There has been an error in programming. Turn the radio off. Use the Instrument Cluster Display Control Buttons to navigate to AUDIO. Record the error message and contact AEV support with the information shown.

TROUBLESHOOTING

Q: No light on the ProCal SNAP.

A: Contact Support.

Q: The light was solid green, I attempted to program something, there was no honk and now the ProCal SNAP has a fast pulsing blue light.

A: Turn the radio off. Use the Instrument Cluster Display Control Buttons to navigate to AUDIO. Record the error message and contact AEV support with the information shown.

Q: What if I don't have a factory stereo?

A: Contact AEV support, some aftermarket radios could still function properly. We'll be able to advise you before trying.

AEV Customer Support: **(248) 926-0256**

Email: **tech@aev-conversions.com**



AEV-CONVERSIONS.COM